

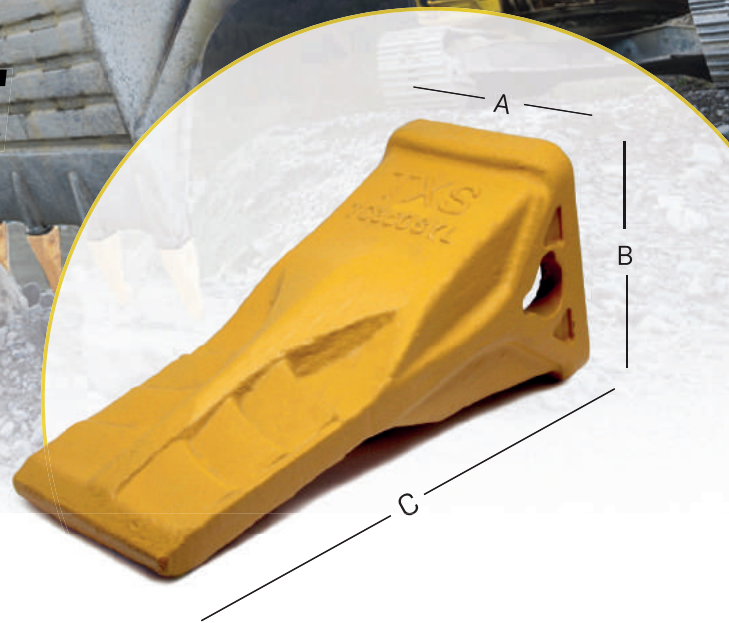



DENT D'EXCAVATRICE CATERPILLAR TXS DRP



SYL DENT SPÉCIALE POUR MEILLEURE PROFONDEUR D'EXCAVATION



| MM/PO | | | KG/L. | RÉF. |  |  |  |
|--------------|---------------|-------------|---------------|-----------|---|---|---|
| A | B | C | | | | | |
| 67 - 2,60 | 70 - 2,76 | 155 - 6,10 | 1,95 - 4,30 | TC200 SYL | 8E-6208 | 4T-0001 8E-6209 | 20 |
| 82 - 3,20 | 103,50 - 4,07 | 210 - 8,27 | 4,00 - 9,00 | TC250 SYL | 8E-6258 132-4763 | 8E-6259 149-5733 | 25 |
| 95 - 3,74 | 110 - 4,33 | 240 - 9,45 | 5,80 - 12,79 | TC300 SYL | 107-3308 132-4766 | 8E-6259 149-5733 | 30 |
| 104 - 4,09 | 120 - 4,72 | 265 - 10,43 | 8,00 - 17,64 | TC350 SYL | 8E-6358 114-0358 | 8E-6359 114-0359 | 35 |
| 132,5 - 5,22 | 139,5 - 5,49 | 307 - 12,09 | 15,35 - 33,84 | TC400 SYL | 116-7408 | 8E-8409 116-7409 | 40 |
| 139 - 4,57 | 146,5 - 5,77 | 322 - 12,68 | 17,00 - 37,48 | TC450 SYL | 114-0468 | 8E-8469 107-3469 | 46 |
| 163,5 - 6,44 | 167 - 6,57 | 368 - 14,49 | 26,00 - 57,33 | TC550 SYL | 107-3378 | 8E-5559 107-8559 | 55 |



DENTS SCARIFICATRICES DE ROCHE ULTRA ROBUSTES À AUTO-AFFÛTAGE

POUR EXCAVATRICE TXS DRR CATERPILLAR



| MM/PO | | | KG/LB | RÉF. |  |  |  |
|-------------|---------------|----------------|--------------|----------|---|---|---|
| A | B | C | | | | | |
| 107 - 4 1/5 | 121 - 4 25/32 | 279 - 11 | 7.3 - 16.1 | TC350 EX | 8E-6358 / 114-0358 | 8E-6359 / 114-0359 | 35 |
| 140 - 5 1/2 | 143 - 5 5/8 | 347 - 13 11/16 | 14.8 - 32.63 | TC450 EX | 114-0468 | 8E-8469 / 107-3469 | 45/46 |
| 165 - 6 1/2 | 167 - 6 19/32 | 379 - 14 15/16 | 20 - 44 | TC550 EX | 107-3378 | 8E-5559 / 107-8559 | 55 |





SANS FRAIS
1-844-TXS(897)-2656
INFO@TXSINDUSTRIALPARTS.COM



TXS DRP EXCAVATRICE CATERPILLAR

RC ROCK CHISEL EXCAVATRICE

| MM | | | KG | REF |  |  |  |
|-----|-----|-----|-------|----------|---|---|---|
| A | B | C | | | | | |
| 67 | 77 | 179 | 2.65 | TC200 RC | 8E-6208 | 4T-0001 8E-6209 | 20 |
| 82 | 96 | 220 | 4.21 | TC250 RC | 8E-6258 132-4763 | 8E-6259 149-5733 | 25 |
| 104 | 120 | 248 | 5.90 | TC300 RC | 107-3308 132-4766 | 8E-6259 149-5733 | 30 |
| 104 | 122 | 281 | 8.80 | TC350 RC | 8E-6358 114-0358 | 8E-6359 114-0359 | 35 |
| 115 | 134 | 309 | 11.60 | TC400 RC | 116-7408 | 8E-8409 116-7409 | 40 |
| 140 | 143 | 330 | 17.30 | TC450 RC | 114-0468 | 8E-8469 107-3469 | 46 |
| 170 | 168 | 384 | 30.30 | TC550 RC | 107-3378 | 8E-5559 107-8559 | 55 |
| 204 | 201 | 463 | 52.70 | TC600 RC | 113-9608 | 6I-6609 113-9609 | 60 |
| 212 | 209 | 481 | 55.30 | TC700 RC | 113-4708 | 4T-4707 113-4709 | 70 |
| 245 | 242 | 523 | 81.50 | TC800 RC | 134-1808 | 134-1809 | 80 |

Tous les noms et/ou numéros des fabricants indiqués ne sont donnés qu'à titre indicatif. TSX n'implique pas que les pièces énumérées soient le produit du fabricant.

SANS FRAIS
1-844-TXS(897)-2656
INFO@TXSINDUSTRIALPARTS.COM



DENTS LARGES STANDARD

**POUR EXCAVATRICE
TXS DRR
CATERPILLAR**

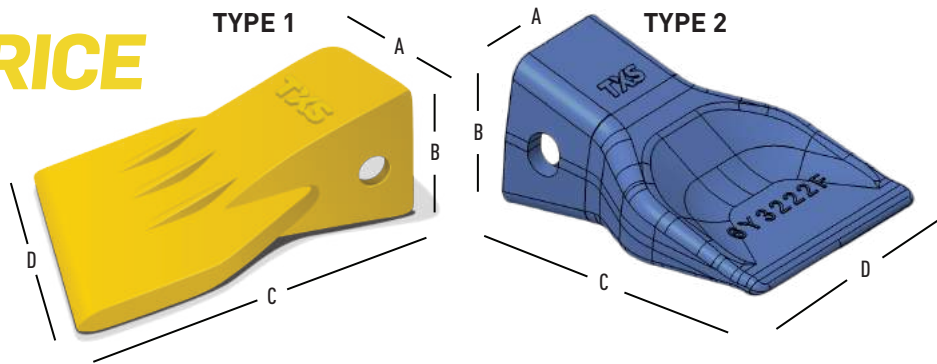

| TYPE | MM/PO | | | | KG/LB | RÉF. | | | |
|------|-------------|-------------|--------------|-------------|---------------|--------------------|----------|---------|----|
| | A | B | C | D | | | | | |
| 1 | 60 - 2 3/8 | 2 5/16 - 59 | 127 - 5 | 111 - 4 3/8 | 1.32 / 2.86 | 1U-3202 FHX | 8E-6208 | 4T-0001 | 20 |
| 2 | 67 - 2 5/8 | 81 - 3 3/16 | 146 - 5 3/4 | 117 - 4 5/8 | 2.7 - 5.9 | 6Y-3222 F | 132-4763 | 8E-6259 | 22 |
| 1 | 86 - 3 3/8 | 98 - 3 7/8 | 216 - 8 1/2 | 152 - 6 | 5.2 - 11.5 | 4T-1300 / 107-3300 | 107-3308 | 8E-6259 | 30 |
| 1 | 102 - 4 | 114 - 4 1/2 | 241 - 9 1/2 | 178 - 7 | 7.6 - 16.7 | 8J-3350 / 107-3350 | 114-0358 | 8E-6359 | 35 |
| 1 | 134 - 5 1/4 | 134 - 5 1/4 | 285 - 11 1/5 | 230 - 9 | 14.60 - 32.19 | 8J-1450 / 107-3450 | 114-0468 | 8E-8469 | 46 |

SANS FRAIS

1-844-TXS(897)-2656



INFO@TXSINDUSTRIALPARTS.COM

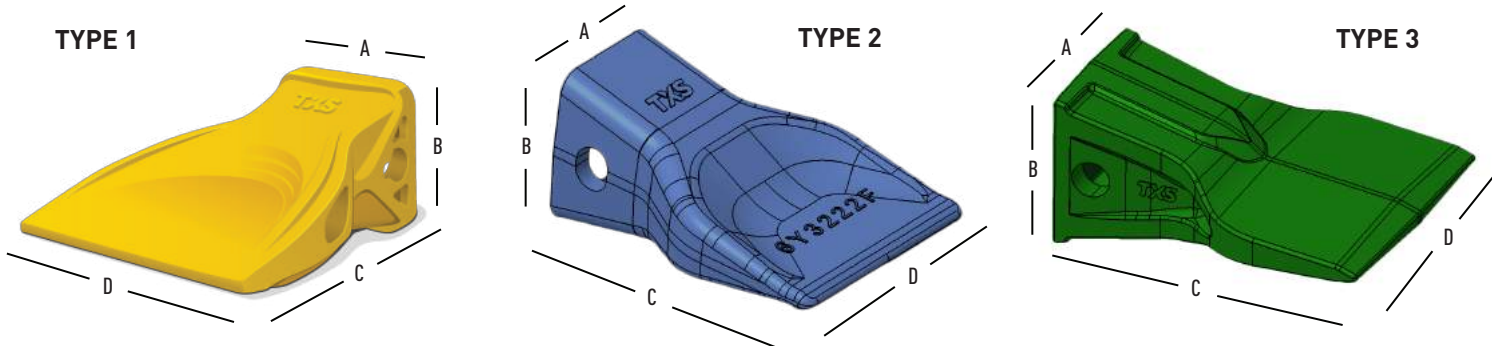

DENTS LARGES SPÉCIALES

POUR EXCAVATRICE TXS DRR CATERPILLAR



| TYPE | MM/PO | | | | KG/LB | RÉF. |  |  |  |
|------|-------------|-------------|---------------|--------------|---------------|--------------------|---|---|---|
| | A | B | C | D | | | | | |
| 1 | 62 - 2 2/5 | 67 - 2 3/5 | 131 - 5 1/6 | 121 - 4 3/4 | 4.00 - 8.82 | TC200 F | 132-4763 | 8E-6259 | 20 |
| 2 | 67 - 2 5/8 | 81 - 3 3/16 | 146 - 5 3/4 | 117 - 4 5/8 | 2.7 - 5.9 | 6Y-3222 F | 132-4763 | 8E-6259 | 22 |
| 3 | 107 - 4 1/5 | 114 - 4 1/2 | 241 - 9 1/2 | 177 - 7 | 7.6 - 16.7 | 107-3350 / 8J-3350 | 114-0358 | 8E-6359 | 35 |
| 1 | 140 - 5 1/2 | 146 - 5 3/4 | 303 - 11 9/10 | 241 - 9 1/2 | 18.7 - 41.23 | TC450 F | 114-0468 | 8E-8469 | 46 |
| 3 | 134 - 5 1/4 | 143 - 5 3/5 | 310 - 12 1/5 | 227 - 8 9/10 | 14.60 - 32.19 | 107-3450 / 8J-1450 | 114-0468 | 8E-8469 | 46 |





SANS FRAIS
1-844-TXS(897)-2656
INFO@TXSINDUSTRIALPARTS.COM



DENTS EXTRA LARGES

POUR EXCAVATRICE TXS DRR CATERPILLAR



| TYPE | MM/PO | | | | KG/LB | RÉF. |  |  |  |
|------|-------------|-------------|--------------|-------------|---------------|----------|---|---|---|
| | A | B | C | D | | | | | |
| 1 | 107 - 4 1/8 | 114 - 4 1/2 | 267 - 10 1/2 | 197 - 7 3/4 | 9,80 - 21,60 | C350 FW | 107-3308 | 8E-6359 | 35 |
| 1 | 127 - 5 | 134 - 5 1/4 | 279 - 11 | 215 - 8 1/2 | 12,80 - 28,22 | C400 FW | 114-0358 | 8E-8409 | 40 |
| 1 | 141 - 5 1/2 | 137 - 5 3/8 | 320 - 12 1/2 | 240 - 9 1/2 | 18,90 - 41,67 | C450 FW | 114-0468 | 8E-0468 | 46 |
| 1 | 141 - 5 1/2 | 137 - 5 3/8 | 320 - 12 1/2 | 254 - 10 | 18,90 - 41,67 | C450 F10 | 114-0468 | 8E-0468 | 46 |



SANS FRAIS
1-844-TXS(897)-2656
INFO@TXSINDUSTRIALPARTS.COM