

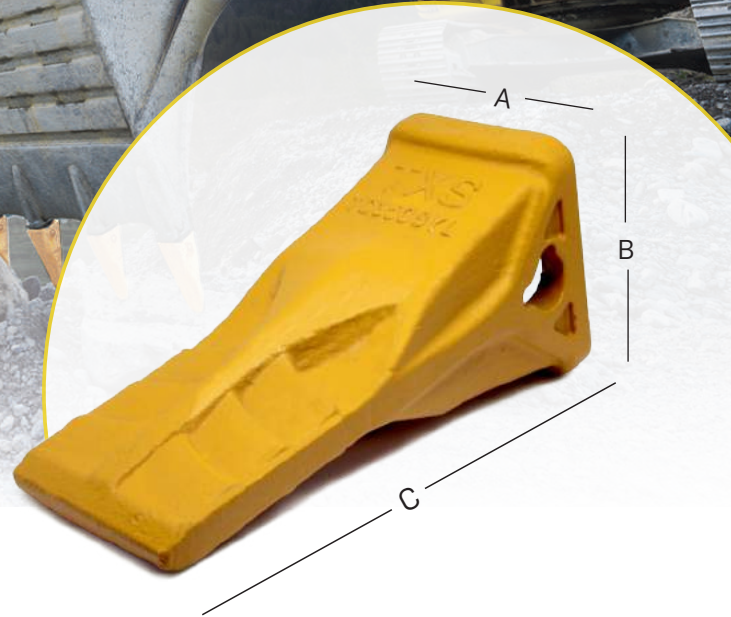



# TXS DRP CATERPILLAR EXCAVATOR TEETH



**SYL SPECIAL EXCAVATOR TOOTH FOR BETTER PENETRATION**



MM/IN			KG/LB	REF			
A	B	C					
67 - 2.60	70 - 2.76	155 - 6.10	1.95 - 4.30	TC200 SYL	8E-6208	4T-0001 8E-6209	20
82 - 3.20	103.50 - 4.07	210 - 8.27	4.00 - 9.00	TC250 SYL	8E-6258 132-4763	8E-6259 149-5733	25
95 - 3.74	110 - 4.33	240 - 9.45	5.80 - 12.79	TC300 SYL	107-3308 132-4766	8E-6259 149-5733	30
104 - 4.09	120 - 4.72	265 -- 10.43	8.00 - 17.64	TC350 SYL	8E-6358 114-0358	8E-6359 114-0359	35
132.5 - 5.22	139.5 - 5.49	307 - 12.09	15.35 - 33.84	TC400 SYL	116-7408	8E-8409 116-7409	40
139 - 4.57	146.5 - 5.77	322 - 12.68	17.00 - 37.48	TC450 SYL	114-0468	8E-8469 107-3469	46
163.5 - 6.44	167 - 6.57	368 - 14.49	26.00 - 57.33	TC550 SYL	107-3378	8E-5559 107-8559	55



# TXS DRR CATERPILLAR EXCAVATOR TEETH

**EX ROCK EXPLODER HEAVY  
DUTY SELF SHARPENING**



MM/IN			KG/LB	REF			
A	B	C					
107 - 4 1/5	121 - 4 25/32	279 - 11	7.3 - 16.1	TC350 EX	8E-6358 / 114-0358	8E-6359 / 114-0359	35
140 - 5 1/2	143 - 5 5/8	347 - 13 11/16	14.8 - 32.63	TC450 EX	114-0468	8E-8469 / 107-3469	45/46
165 - 6 1/2	167 - 6 19/32	379 - 14 15/16	20 - 44	TC550 EX	107-3378	8E-5559 / 107-8559	55





**TOLL FREE**  
1-844-TXS(897)-2656  
INFO@TXSINDUSTRIALPARTS.COM



# TXS DRP CATERPILLAR EXCAVATOR TEETH

## RC ROCK CHISEL EXCAVATOR TOOTH

IN			LB	REF			
A	B	C					
2.60	3.03	7.05	5.86	TC200 RC	8E-6208	4T-0001 8E-6209	20
3.20	3.77	8.66	9.27	TC250 RC	8E-6258 132-4763	8E-6259 149-5733	25
4.09	4.72	9.76	13.00	TC300 RC	107-3308 132-4766	8E-6259 149-5733	30
4.07	4.78	11.04	19.40	TC350 RC	8E-6358 114-0358	8E-6359 114-0359	35
4.51	5.26	12.15	25.58	TC400 RC	116-7408	8E-8409 116-7409	40
5.50	5.62	12.99	38.15	TC450 RC	114-0468	8E-8469 107-3469	46
6.67	6.59	15.10	66.80	TC550 RC	107-3378	8E-5559 107-8559	55
8.02	7.91	18.22	116.20	TC600 RC	113-9608	6I-6609 113-9609	60
8.34	8.22	18.93	121.94	TC700 RC	113-4708	4T-4707 113-4709	70
9.63	9.51	20.57	179.71	TC800 RC	134-1808	134-1809	80

Any Manufacturer names and or numbers listed are shown for reference only. TXS does not imply that any listed parts are the product of the manufacturer

TOLL FREE

1-844-TXS(897)-2656

INFO@TXSINDUSTRIALPARTS.COM





# TXS DRR CATERPILLAR EXCAVATOR STANDARD WIDE TEETH

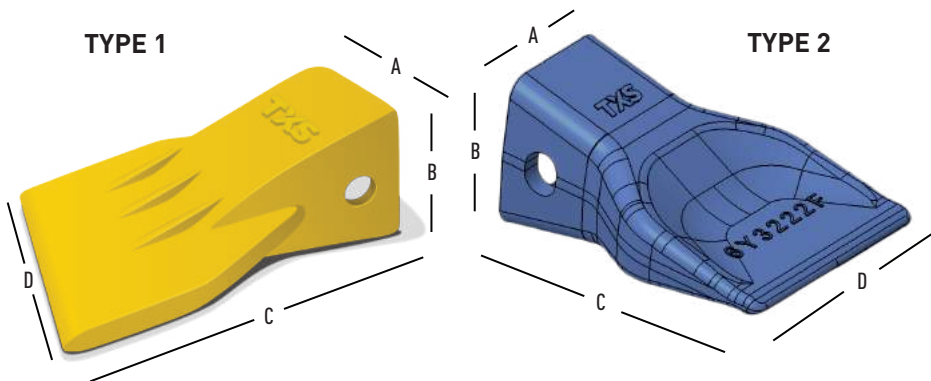





TYPE	MM/IN				KG/LB	REF			
	A	B	C	D					
1	60 - 2 3/8	25/16 - 59	127 - 5	111 - 4 3/8	1.32 / 2.86	1U-3202 FHX	8E-6208	4T-0001	20
2	67 - 2 5/8	81 - 3 3/16	146 - 5 3/4	117 - 4 5/8	2.7 - 5.9	6Y-3222 F	132-4763	8E-6259	22
1	86 - 3 3/8	98 - 3 7/8	216 - 8 1/2	152 - 6	5.2 - 11.5	4T-1300 / 107-3300	107-3308	8E-6259	30
1	102 - 4	114 - 4 1/2	241 - 9 1/2	178 - 7	7.6 - 16.7	8J-3350 / 107-3350	114-0358	8E-6359	35
1	134 - 5 1/4	134 - 5 1/4	285 - 11 1/5	230 - 9	14.60 - 32.19	8J-1450 / 107-3450	114-0468	8E-8469	46

**TOLL FREE**  
**1-844-TXS(897)-2656**  
 INFO@TXSINDUSTRIALPARTS.COM

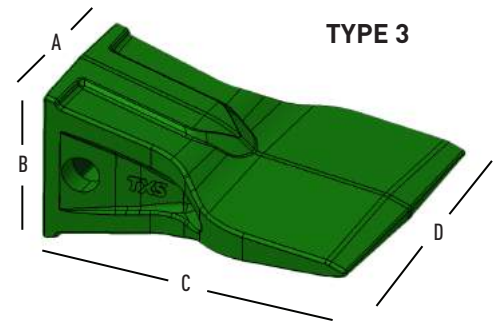
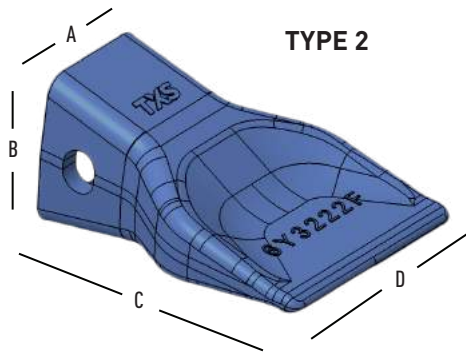
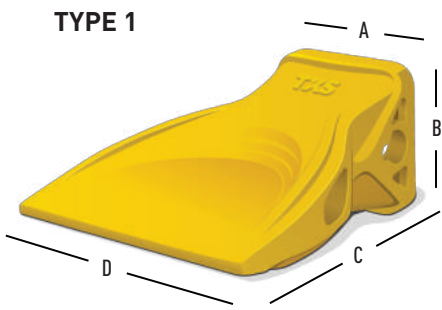

# TXS DRR CATERPILLAR EXCAVATOR SPECIAL WIDE TEETH



TYPE	MM/IN				KG/LB	REF			
	A	B	C	D					
1	62 - 2 2/5	67 - 2 3/5	131 - 5 1/6	121 - 4 3/4	4.00 - 8.82	TC200 F	132-4763	8E-6259	20
2	67 - 2 5/8	81 - 3 3/16	146 - 5 3/4	117 - 4 5/8	2.7 - 5.9	6Y-3222 F	132-4763	8E-6259	22
3	107 - 4 1/5	114 - 4 1/2	241 - 9 1/2	177 - 7	7.6 - 16.7	107-3350 / 8J-3350	114-0358	8E-6359	35
1	140 - 5 1/2	146 - 5 3/4	303 - 11 9/10	241 - 9 1/2	18.7 - 41.23	TC450 F	114-0468	8E-8469	46
3	134 - 5 1/4	143 - 5 3/5	310 - 12 1/5	227 - 8 9/10	14.60 - 32.19	107-3450 / 8J-1450	114-0468	8E-8469	46







**TOLL FREE**  
 1-844-TXS(897)-2656  
 INFO@TXSINDUSTRIALPARTS.COM



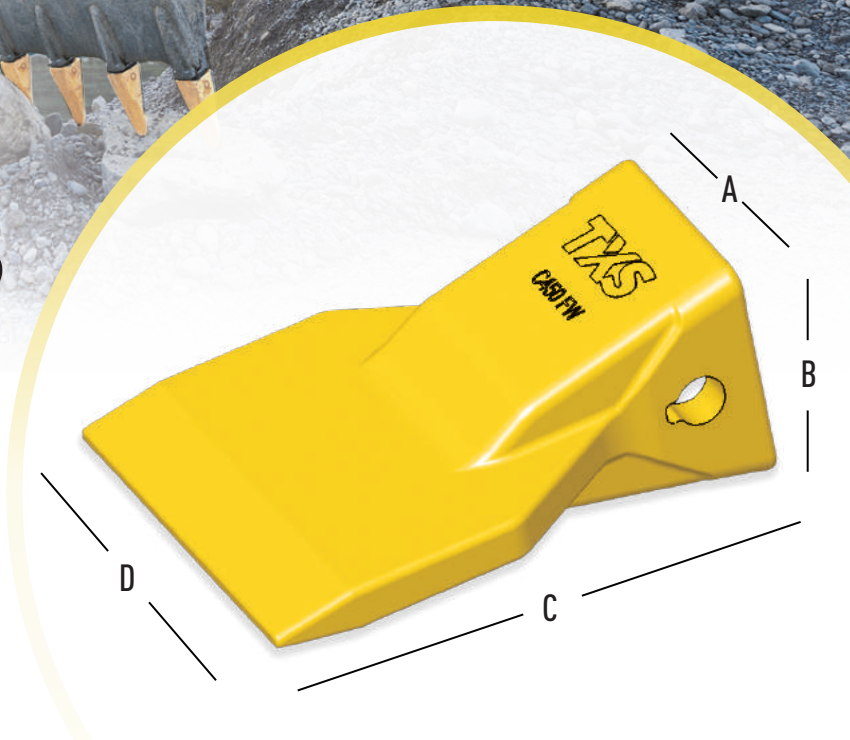

# TXS DRR CATERPILLAR EXCAVATOR EXTRA WIDE TEETH



TYPE	MM/IN				KG/LB	REF			
	A	B	C	D					
1	107 - 4 1/8	114 - 4 1/2	267 - 10 1/2	197 - 7 3/4	9,80 - 21,60	C350 FW	107-3308	8E-6359	35
1	127 - 5	134 - 5 1/4	279 - 11	215 - 8 1/2	12,80 - 28,22	C400 FW	114-0358	8E-8409	40
1	141 - 5 1/2	137 - 5 3/8	320 - 12 1/2	240 - 9 1/2	18,90 - 41,67	C450 FW	114-0468	8E-0468	46
1	141 - 5 1/2	137 - 5 3/8	320 - 12 1/2	254 - 10	18,90 - 41,67	C450 F10	114-0468	8E-0468	46



**TOLL FREE**  
1-844-TXS(897)-2656  
INFO@TXSINDUSTRIALPARTS.COM